



Top Selling Stock Ready Luminaires

2023 Q3 Select Edition

CHLORIDE

LIGHTOLIER

Day-Brite

Stonco

Top Stock Ready Items

**Stock, Sell, and Restock with
Signify's best movers!**

Save time and improve efficiencies by consolidating your stock purchases with Signify's top stocking product families which includes a wide range of unique adjustable color temperature and/or lumen outputs field selectable product lines. These products are priced right and ready to go!

To learn more about our stock ready offerings
visit us at www.signify.com/readytogo



A long history of excellence

As the global leader in lighting for more than 130 years, Signify has the know-how and most comprehensive portfolio to meet any application. We achieved 100% Carbon Neutrality in 2020. We are number 1 in conventional lamps, LED and Connected lighting. We have over 17,750 patents. We invest 4.8% of total sales in R&D which is two times our nearest competitor! Partnership is more than sales.

Let's grow together. We are ready to go with you.

Quick and reliable service out of our distribution centers.

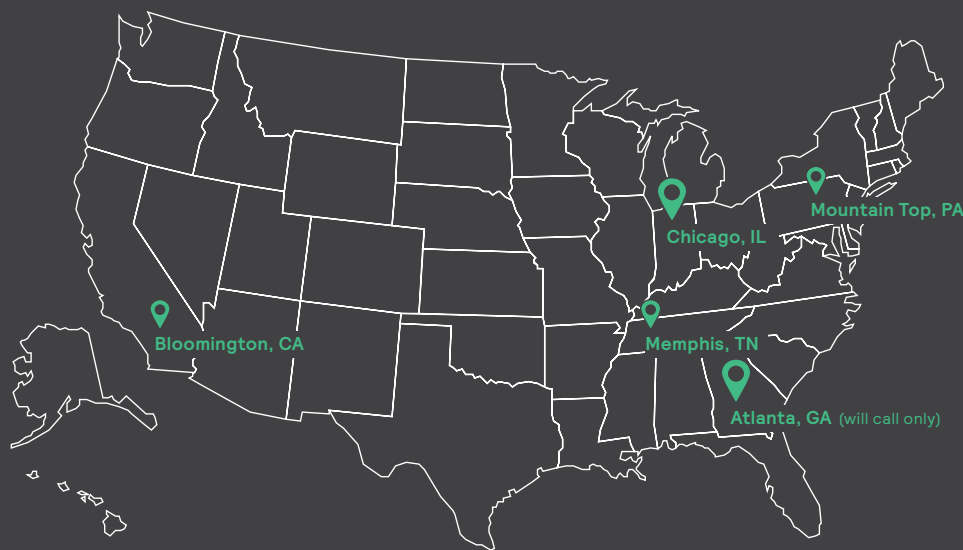

Find just what you need

Our Stock Ready portfolio makes it easy to find just what you need. Our products are designed for easy ordering through the Signify portal, easy to install with minimal steps, and competitively priced to meet the demands of budget conscious projects focused on cost and energy. Distributors can also benefit from our Stock Ready program which offers deals on freight, guaranteed sales, price change reimbursement, delistment notifications, marketing support, merchandising, and more.

Certifications & labels



interact
ready.

The right solution

Signify provides the solution to every lighting need whether it's lighting and connecting your public spaces, giving your commercial building an energy saving upgrade, or working on a yet to be constructed hospital, we've got you covered.

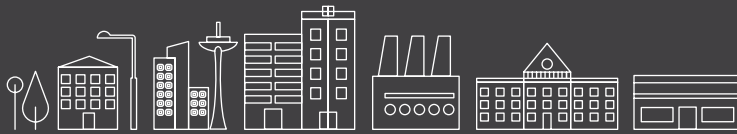

Government

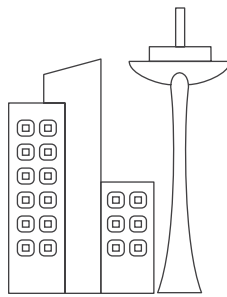

Cities

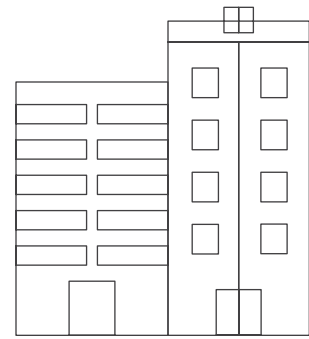

Offices

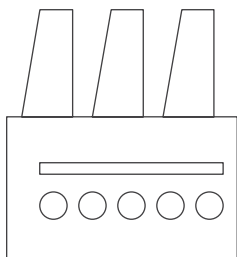

Industry

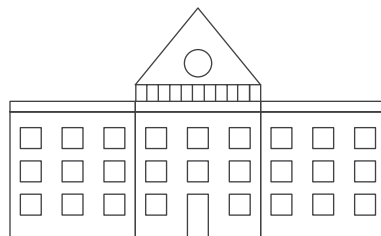

Education

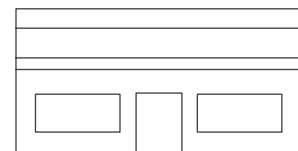

Retail

Stock up on our new field selectable products

With the unique convenience of adjustable color temperatures and/or lumen outputs, our new Field Selectable product lines make it easy to always have the right product for the job. Field Selectable products give you the added benefit of carrying one SKU versus multiple SKUs, keeping your inventory low and turns high. These product lines are priced right as part of our stock ready offering.



Lumen Select Switch



CCT with Select Switch

LIGHTOLIER

Day-Brite

Stonco



Flat Downlight
LED dual select



Commercial Retrofit Downlight
LED dual select



Residential Retrofit Downlight
LED select



Gimbal & Downlight
LED dual select



Surface Mount Downlight
LED dual select



SDS Selectable Strip
LED dual select



NWL Wraparound
LED select



FCY Value High Bay
LED dual select



VTS Vaportight
LED dual select



Selectable Backlit Panel
LED select



Slim Flood
LED dual select



Wall Pack
LED dual select



Adjustable Slim Wall Pack
LED dual select

Indoor & Outdoor luminaires

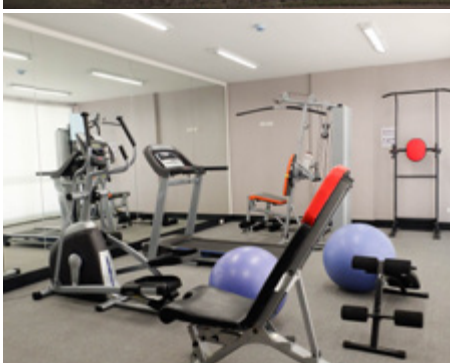

Indoor luminaires



Residential Retrofit Downlight 1



Commercial Retrofit Downlight 2

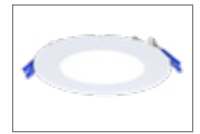

Flat Downlight 3



Surface Mount Downlight 4



Downlight & Gimbal 5



FCY Value High Bay 6



Select Backlit Panel 7

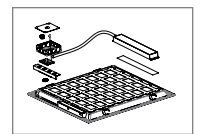

FPDM 8

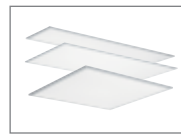

FlatPanel Gen2 9



SDS Selectable Strip 10



NWL Wraparound 11



VTS Sealed Strip 12



Exit signs 13



Value+ Family 14

Outdoor luminaires



Slim Flood LED dual select 15



Wall Pack LED dual select 16



Adj. Slim Wall Pack LED dual select 17

Residential Retrofit Downlight 5/6"

Residential Retrofit Downlight 4"



Top selling residential product

Residential Retrofit Downlight

An LED retrofit as **easy as snap and click**

Hassle-free install will save you time and frustration on the job site. You may not even need to open your toolbox.



Why choose Retrofit Downlight?

- Adjustable color temperature switch allows you to make choices while your install or afterward
- Utilizes existing frames to make replacing old downlighting and upgrading to LED a truly easy task
- Flexible springs allow for installation without tools
- Quick-connect plug and medium-based socket adapter means no extra accessories to purchase

Residential Retrofit Downlight LED select

Catalog Number	UPC Code	Model Number	Product Description	Compliance	Case/Pallet Qty	Distribution Center
Residential Retrofit Downlight 4" Round						
RD4R79301W	190096131976	911401868184	Retrofit Downlight 4" Round 700 lumen 90CRI 3000K 120V	Energy Star	16/560	PA TN CA
RD4R79SCT1W	190096131952	911401867984	Retrofit Downlight 4" Round 700 lumen 90CRI 5CCT 120V	Energy Star	12/300	PA TN CA
Residential Retrofit Downlight 5/6" Round						
RD6R99301W	190096131983	911401868284	Retrofit Downlight 6" Round 900 lumen 90CRI 3000K 120V	Energy Star	16/560	PA TN CA
RD6R99SCT1W	190096131969	911401868084	Retrofit Downlight 6" Round 900 lumen 90CRI 5CCT 120V	Energy Star	12/300	PA TN CA



Commercial Retrofit Downlight

Bright, brighter, **brightest**

Will reduce onsite time and headaches for busy installers with its adjustable lumen and color output switch.



Why choose Commercial Retrofit Downlight?

- Adjustable lumen output and color temperature switch allows you to make choices while you install or afterward
- Great for different ceiling heights and different light level needs
- Sturdy metal clips provide a solid fit and easy installation
- Out-of-the-box pre-wired with flexible metal conduit
- 50,000 hour rated life (L70)



Commercial Retrofit Downlight LED dual select

Catalog Number	UPC Code	Model Number	Product Description	Compliance	Case/Pallet Qty	Distribution Center
Commercial Retrofit Downlight 6" Round						
CR6RLMCCT	190096131273	911401870181	6" Round, 700-1500lm 90CRI 3000K-3500K-4000K White Finish 120-347V	—	120	CA, TN, PA
Commercial Retrofit Downlight 8" Round						
CR8RLMCCT	190096131280	911401870281	8" Round, 1000-2000lm 90CRI 3000K-3500K-4000K White Finish 120-347V	—	72	CA, TN, PA



Lumen Select Switch



CCT with Select Switch



Downlight



Gimbal

Downlight and Gimbal

The CCT and Lumen selection features make it easy to adjust at the time of installation.



Why choose Downlight and Gimbal?

- Sizes: 3, 4, & 6 inch round
- Dimming: TRIAC down to 10%
- Installation: Easy with detachable junction box
- Lifetime: L70 at 50,000 hours
- Listings: ENERGY STAR®, Title 24 (JA8-2016), damp location, ETL listed. Airseal IC.
- Warranty: 5 year limited

Downlight and Gimbal LED dual select

Catalog Number	UPC Code	Model Number	Product Description	Compliance	Case/Pallet Qty	Dist. Center
Downlight 3" Round						
DL3RSLMZ10SCTUW	190096131853	911401837684	3" Round, Downlight 370lm/500lm 2700K-3000K-3500K-4000K-5000K UNV	Energy Star	8/320	PA TN CA
DL3R4ESCT1W	190096196234	911401884284	3" Round, Downlight 500lm 2700K-3000K-3500K-4000K-5000K 120V	Energy Star	8/384	PA TN CA
Downlight 4" Round						
DL4RSLMZ10SCTUW	190096131877	911401837884	4" Round, Downlight 540lm/700lm 2700K-3000K-3500K-4000K-5000K UNV	Energy Star	8/240	PA TN CA
DL4R7ESCT1W	190096131860	911401837784	4" Round, Downlight 700lm 2700K-3000K-3500K-4000K-5000K 120V	Energy Star	20/640	PA TN CA
Downlight 6" Round						
DL6RSLMZ10SCTUW	190096131891	911401838084	6" Round, Downlight 900lm/1100lm 2700K-3000K-3500K-4000K-5000K UNV	Energy Star	8/160	PA TN CA
DL6R1ESCT1W	190096131884	911401837984	6" Round, Downlight 1100lm 2700K-3000K-3500K-4000K-5000K 120V	Energy Star	10/300	PA TN CA
Gimbal 3" Round						
GB3RSLMZ10SCTUW	190096131907	911401837184	3" Round, Gimbal 370lm/500lm 2700K-3000K-3500K-4000K-5000K UNV	Energy Star	8/320	PA TN CA
GB3R4ESCT1W	190096196227	911401884184	3" Round, Gimbal 500lm 2700K-3000K-3500K-4000K-5000K 120V	Energy Star	8/384	PA TN CA
Gimbal 4" Round						
GB4RSLMZ10SCTUW	190096131921	911401837384	4" Round, Gimbal 540lm/700lm 2700K-3000K-3500K-4000K-5000K UNV	Energy Star	8/240	PA TN CA
GB4R7ESCT1W	190096131914	911401837284	4" Round, Gimbal 700lm 2700K-3000K-3500K-4000K-5000K 120V	Energy Star	8/480	PA TN CA
Gimbal 6" Round						
GB6RSLMZ10SCTUW	190096131945	911401837584	6" Round, Gimbal 900lm/1100lm 2700K-3000K-3500K-4000K-5000K UNV	Energy Star	8/160	PA TN CA
GB6R1ESCT1W	190096131938	911401837484	6" Round, Gimbal 1100lm 2700K-3000K-3500K-4000K-5000K 120V	Energy Star	6/240	PA TN CA

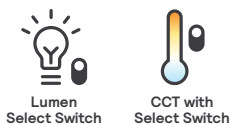

Surface Mount Downlight

The shallow ceiling **problem solver**

Ideal when faced with a challenging ceiling, but you still want a good-looking downlight.

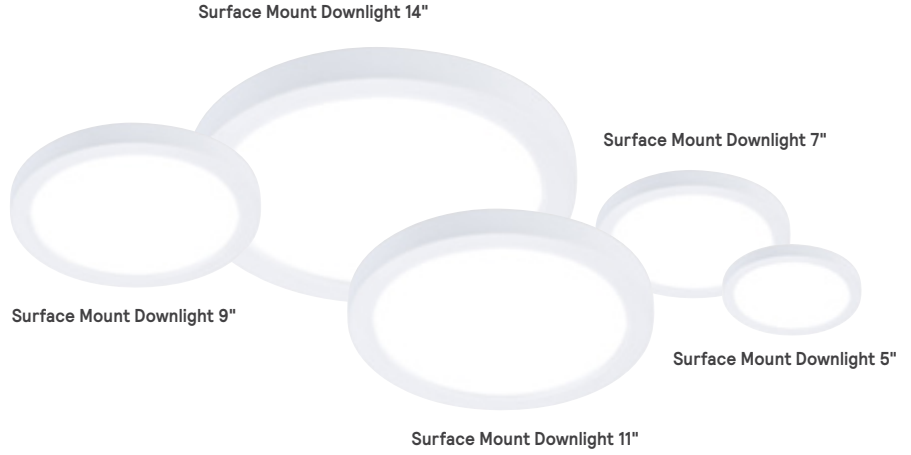

Why choose Surface Mount Downlight?

- Easy to install on standard J-boxes
- Surface mount downlight solves the problem of limited plenum space
- Glare controlling lens for comfortable light distribution
- Affordable alternative to Air-Seal IC recessed housings
- Support wire attached for easy installation
- ENERGY STAR and Title 24 listed



Surface Mount Downlight LED dual select

Catalog Number	UPC Code	Model Number	Product Description	Compliance	Case/Pallet Qty	Distribution Center
Surface Mount Downlight 5" Round						
SD5R7ESCT1W	190096131785	911401836484	5" Round, 700lm 90CRI 2700K-3000K-3500K-4000K-5000K 120V	Energy Star	8/672	PA TN CA
SD5RSLMZ10SCTUW	190096131792	911401836584	5" Round, 540lm/700lm 90CRI 2700K-3000K-3500K-4000K-5000K UNV	Energy Star	8/672	PA TN CA
Surface Mount Downlight 7" Round						
SD7R10ESCT1W	190096131808	911401836684	7" Round, 1000lm 90CRI 2700K-3000K-3500K-4000K-5000K 120V	Energy Star	8/360	PA TN CA
SD7RSLMZ10SCTUW	190096131815	911401836784	7" Round, 800lm/1000lm 90CRI 2700K-3000K-3500K-4000K-5000K UNV	Energy Star	8/360	PA TN CA
Surface Mount Downlight 9" Round						
SD9RSLMZ10SCTUW	190096131822	911401836884	9" Round, 900lm/1200lm 90CRI 2700K-3000K-3500K-4000K-5000K UNV	Energy Star	8/192	PA TN CA
SD9R12ESCT1W	190096196197	911401883884	9" Round, 1200lm 90CRI 2700K-3000K-3500K-4000K-5000K 120V	Energy Star	8/192	PA TN CA
Surface Mount Downlight 11" Round						
SD11RSLMZ10SCTUW	190096131839	911401836984	11" Round, 1200lm/1500lm 90CRI 2700K-3000K-3500K-4000K-5000K UNV	Energy Star	6/162	PA TN CA
SD11R15ESCT1W	190096196203	911401883984	11" Round, 1500lm 90CRI 2700K-3000K-3500K-4000K-5000K 120V	Energy Star	6/162	PA TN CA
Surface Mount Downlight 14" Round						
SD14RSLMZ10SCTUW	190096131846	911401837084	14" Round, 1600lm/2000lm 90CRI 2700K-3000K-3500K-4000K-5000K UNV	Energy Star	6/90	PA TN CA
SD14R16ESCT1W	190096196210	911401884084	14" Round, 2000lm 90CRI 2700K-3000K-3500K-4000K-5000K 120V	Energy Star	5/90	PA TN CA



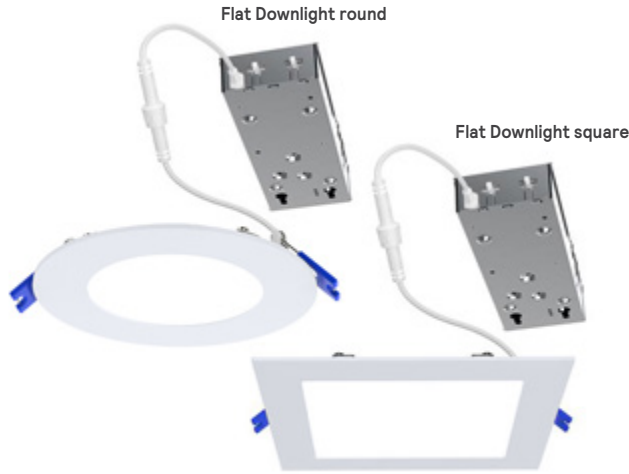

Flat Downlight

Make your next lighting project faster and easier, with a product from a name you can trust.



Why choose Flat Downlight?

- FD select: 4 field selectable CCT options
- FD dual select: 5 field selectable CCT and multiple lumen selection options
- Quick and easy installation without frame or reflector
- Junction box clips to luminaire meeting National Electric Code (NEC)
- Dimmable to 10%
- Lifetime >50,000 hours (L70)
- IC-rated for insulation direct contact
- UL1598 wet location rated

Flat Downlight LED dual select

Catalog Number	UPC Code	Model Number	Product Description	Compliance	C/P Qty	Dist. Center
Flat Downlight Round						
FD3R7ESCT1W	190096196166	911401883584	3" Round, 480lm 2700K-3000K-3500K-4000K-5000K White Finish 120V	Energy Star	12/384	PA TN CA
FD3RSLMZ10SCTUW	190096131679	911401825284	3" Round, 370lm/500lm 90CRI 2700K-3000K-3500K-4000K-5000K White Finish UNV	Energy Star	12/288	PA TN CA
FD4R7ESCT1W	190096131686	911401825384	4" Round, 700lm 2700K-3000K-3500K-4000K-5000K White Finish 120V	Energy Star	20/360	PA TN CA
FD4RSLMZ10SCTUW	190096131693	911401825484	4" Round, 540lm/700lm 2700K-3000K-3500K-4000K-5000K White Finish UNV	Energy Star	12/216	PA TN CA
FD5R9ESCT1W	190096196173	911401883684	5" Round, 900lm 2700K-3000K-3500K-4000K-5000K White Finish 120V	Energy Star	6/270	PA TN CA
FD5RSLMZ10SCTUW	190096131709	911401825584	5" Round, 900lm/1100lm 2700K-3000K-3500K-4000K-5000K White Finish UNV	Energy Star	6/180	PA TN CA
FD6R11ESCT1W	190096131716	911401825684	6" Round, 1100lm 2700K-3000K-3500K-4000K-5000K White Finish 120V	Energy Star	10/300	PA TN CA
FD6RSLMZ10SCTUW	190096131723	911401825784	6" Round, 900lm/1100lm 2700K-3000K-3500K-4000K-5000K White Finish UNV	Energy Star	6/180	PA TN CA
FD8R13ESCT1W	190096196180	911401883784	8" Round, 1300lm 2700K-3000K-3500K-4000K-5000K White Finish 120V	Energy Star	6/144	PA TN CA
FD8RSLMZ10SCTUW	190096131730	911401825884	8" Round, 1100lm/1300lm 2700K-3000K-3500K-4000K-5000K White Finish UNV	Energy Star	6/144	PA TN CA
Flat Downlight Square						
FD3SSLMZ10SCTUW	190096131747	911401825984	3" Square, 370lm/500lm 2700K-3000K-3500K-4000K-5000K White Finish UNV	Energy Star	12/288	PA TN CA
FD4SSLMZ10SCTUW	190096131754	911401826084	4" Square, 540lm/700lm 2700K-3000K-3500K-4000K-5000K White Finish UNV	Energy Star	12/216	PA TN CA
FD6SSLMZ10SCTUW	190096131761	911401826184	6" Square, 900lm/1100lm 2700K-3000K-3500K-4000K-5000K White Finish UNV	Energy Star	6/180	PA TN CA
FD8SSLMZ10SCTUW	190096131778	911401826284	8" Square, 1100lm/1300lm 2700K-3000K-3500K-4000K-5000K White Finish UNV	Energy Star	6/144	PA TN CA
Flat Downlight Accessory						
FD4NCP	190096131198	911401865081	4" New Construction Plate	—	40/2800	Factory
FD6NCP	190096131204	911401865181	6" New Construction Plate	—	40/2000	Factory

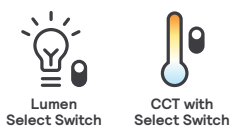

FCY Value High Bay

Update and upgrade for **real savings**

Low profile and durable design, efficiency and great price – FCX value high bay has it all.



Field CCT selectable 4000K or 5000K

Why choose FCY Value High Bay?

- Die formed sheet metal housing and end plates
- Corrosion resistant gloss white paint after fabrication
- V-hooks and 48" chains supplied (set of 2) for installation
- Lumen maintenance up to 70% (L70) at 50,000 hours
- Access plate located on top of housing for easy wiring
- cULus listed for use in damp locations, -20°C to 45°C ambient



FCY Value High Bay

Catalog Number	UPC Code	Model Number	Product Description	Compliance	Case/Pallet Qty	Distribution Center
FCY Value High Bay						
FCY15L8CST-UNV-DIM	190096180653	912401590942	15,000 lumen, 80CRI, Color Select 4000K/5000K, 0-10V, UNV 120-347V	DLC Premium	1/27	IL, TN, PA, CA, GA
FCY22L8CST-UNV-DIM	190096180660	912401590943	22,000 lumen, 80CRI, Color Select 4000K/5000K, 0-10V, UNV 120-347V	DLC Premium	1/27	IL, TN, PA, CA, GA

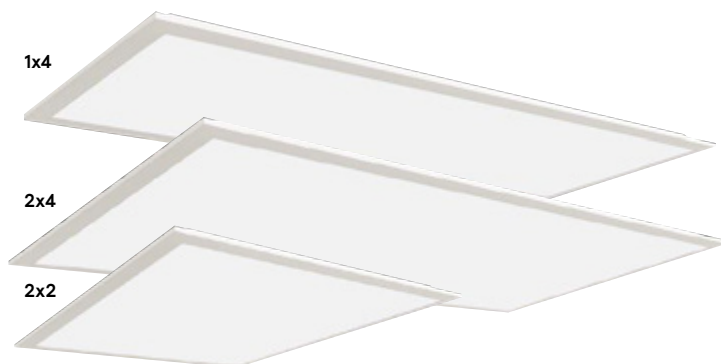

Selectable Backlit Panel

Make the **easy selection** and carry less stock with more options.



Why choose Selectable Backlit Panel?

- 3 color temperature selections, 3 wattage choices, and 3 sizes available
- Numerous options for your customers, while keeping inventory levels and SKU count low
- Available for use in recessed, suspended and surface mount applications

Selectable Backlit Panel

Catalog Number	UPC Code	Model No.	Product Description	Compliance	C/P Qty	Dist. Center
Selectable Backlit Panel						
2SBP3040L8CS-2-UNV-DIM	190096131006	911401837781	2x2, Lumens Select, 80CRI, Color Select 3500K/4000K/5000K, UNV 120-277V, 0-10V (30W/34W/39W)	DLC Standard	4/40	CA, TN, PA, IL, GA*
2SBP3550L8CS-4-UNV-DIM	190096131013	911401837881	2x4, Lumens Select, 80CRI, Color Select 3500K/4000K/5000K, UNV 120-277V, 0-10V (35W/38W/50W)	DLC Standard	4/20	CA, TN, PA, IL, GA*



FPEM

Ideal for renovations and new construction opportunities where remote mounting is a necessity.

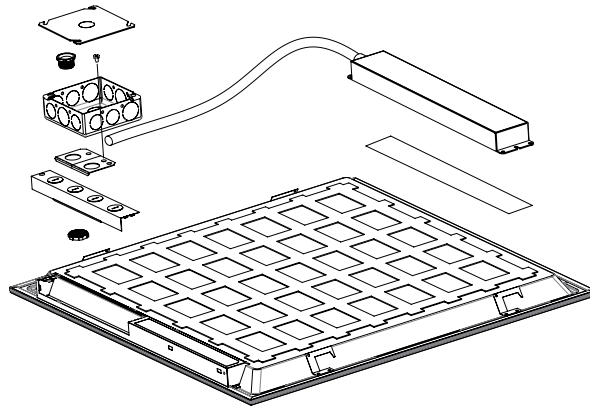

Why choose FPEM?





- A simple, time saving solution for emergency remote mounting applications
- Designed for use with several configurations of panels, wraps, and strips product families
- Operates an LED load of up to 10.4 W at nominal battery voltage for a minimum of 90 minutes
- Indicator test switch and plate mounting compatibility with grid ceiling, drywall, or open ceiling application



FluxPanel

Catalog Number	UPC Code	Model Number	Product Description	Case/Pallet Qty	Distribution Center
FluxPanel Gen2					
FPEMLED10RM	784197707941	912401608930	Emergency LED driver, Class 2, 10W, compatible with Selectable Panel / NWL Wrap / SDS Strip / FCY	1/120	CA, TN, PA

Product families compatible with the FPEM

FluxPanel SBP	FluxPanel FPZ	NWL Wraparound	SDS LED
FluxPanel Selectable LED flat panel	FluxPanel Gen2 LED flat panel	NWL Wraparound LED	SDS LED Selectable Strip
			



FluxPanel gen 2

Uniform surface of light provides low glare, flicker free lighting at an affordable price.



Why choose FluxPanel Gen2?

- DLC standard and premium options to assure performance and maximum ROI
- Tested TM21 prediction L70 up to 90,000 hrs and warranted for 5 years¹
- Install the remote mount sensor accessory to capture maximum savings now and expand the network for add on sales and value in the future
- Flexible wiring options
- Available with factory installed BSL10LST self test 10W and BSL6LST self test 6W ...more lumen output for 1 watt less

FluxPanel

Catalog Number	UPC Code	Model Number	Product Description	Compliance	Case/Pallet Qty	Distribution Center
FluxPanel Gen2						
2FPZ38B835-2-DS-UNV-DIM	190096180035	912401609018	2x2, 3800 lumen, 80CRI, 3500K, Smooth Diffuser, UNV 120-277V, 0-10V	DLC Standard	1/40	CA, TN, PA
2FPZ38B840-2-DS-UNV-DIM	190096180042	912401609019	2x2, 3800 lumen, 80CRI, 4000K, Smooth Diffuser, UNV 120-277V, 0-10V	DLC Standard	1/40	CA, TN, PA, IL
2FPZ42B835-4-DS-UNV-DIM	190096180066	912401609021	2x4, 4200 lumen, 80CRI, 3500K, Smooth Diffuser, UNV 120-277V, 0-10V	DLC Standard	1/20	CA, TN, PA
2FPZ42B840-4-DS-UNV-DIM	190096180073	912401609022	2x4, 4200 lumen, 80CRI, 4000K, Smooth Diffuser, UNV 120-277V, 0-10V	DLC Standard	1/20	CA, TN, PA, IL

1. Visit signify.com/warranties for full warranty information.



NWL Selectable Wraparound

Achieve a balance of performance and appeal



NWL
(Wraparound)
with field on/off
occupancy sensor

Why choose NWL Selectable Wraparound?

- White polycarbonate housing for durability
- Frosted polycarbonate lens for even, low glare lighting
- Hardware for surface mounting included
- Field CCT selectable for 3000K, 3500K or 4000K
- cETLus listed to meet UL 1598 standards for -10°C to 35°C ambient. Suitable for damp locations



NWL Selectable Wraparound

Catalog Number	UPC Code	Model No.	Product Description	Compliance	C/P Qty	Dist. Center
NWL Selectable Wraparound						
NWL440L8CST-UNV-DIM-OCC	190096130917	911401803581	4' Length, 4000lm, 80CRI, Color Select 3000K-3500K-4000K, UNV 120-277V, 0-10V, Occupancy sensor	DLC Standard	4/32	CA, TN, PA, IL, GA*

* Will Call (pickup only)





SDS
(Selectable Strip)

SDS Selectable Strip

Economical luminaire
delivering the right light



Why choose SDS Selectable LED Strip?

- Simple form
- Convenient specification
- Ease of installation
- Ease of maintenance
- Durable construction
- Simple mounting method
- Frosted glare-free lens
- CCT & Lumen selectability

SDS Selectable Strip

Catalog Number	UPC Code	Model Number	Product Description	Compliance	Case/Pallet Qty	Dist. Center
Linear Strip SDS						
SDS21224L8CST-UNV-DIM	190096131563	911401870782	2', 1200/1800/2400 lumen, 3500K/4000K/5000K (CRI 80), UNV, Dimmable	DLC Standard	288	PA, CA, TN, IL
SDS42448L8CST-UNV-DIM	190096131570	911401870882	4', 2430/3640/4850 lumen, 3500K/4000K/5000K (CRI 80), UNV, Dimmable	DLC Standard	144	PA, CA, TN, IL
SDS84998L8CST-UNV-DIM	190096131587	911401870982	8', 4900/7350/9800 lumen, 3500K/4000K/5000K (CRI 80), UNV, Dimmable	DLC Standard	36	PA, CA, TN, IL



VTS Sealed Strip

Dual selectable sealed strip for indoor and outdoor applications

Sealed Strip luminaire offers rugged reliability, selectability and the efficiency your successful business requires.



Why choose VTS Sealed Strip?

- Ideally suited for use in refrigerated cold storage, industrial, parking garage, and canopy applications.
- Acceptable for outdoor as well as indoor installations.
- Can be surface mounted on ceilings or walls, or suspended via brackets, chain or cables (2ft, 4ft or 8ft option).
- Selectable (3500, 4000 or 5000K) default setting is 4000K correlated color temperature (CCT) with max available power.



VTS Sealed Strip LED dual select

Catalog Number	UPC Code	Model Number	Product Description	Compliance	Case/Pallet Qty	Distribution Center
VTS Sealed Strip						
VTS225L840-UN3-DIM	190096196562	911401827085	2ft 2500lm 4000K 120-347V	DLC Standard	6/144	TN PA CA
VTS22028L8CST-UN3-DIM	190096196517	911401824985	2ft 20/24/28lm 3CCT 120-347V	DLC Standard	6/144	TN PA CA
VTS450L840-UN3-DIM	190096196524	911401825085	4ft 5000lm 4000K 120-347V	DLC Standard	4/64	TN PA CA
VTS42856L8CST-UN3-DIM	190096196531	911401825185	4ft 28/42/56lm 3CCT 120-347V	DLC Standard	4/64	TN PA CA
VTS8100L840-UN3-DIM	190096196548	911401825285	8ft 10000lm 4000K 120-347V	DLC Standard	2/64	TN PA CA
VTS880130L8CST-UN3-DIM	190096196555	911401825385	8ft 80/110/130lm 3CCT 120-347V	DLC Standard	2/64	TN PA CA





Value+ LED Exit Signs

Basic exit that offers a low profile design, giving it stylish appeal suitable for any general purpose application.



Why choose Value+ Family?

- Thermoplastic (off white) ABS housing
- Low profile, snap together quick mount design
- Universal wall/ceiling/end mounting
- UL damp location listed
- Pop out chevron directional indicators are easily removed when required
- Extra stencil faceplate for double face sign applications
- 6V maintenance free nickel cadmium battery

Value+ LED Exit Signs

Catalog Number	UPC Code	Model Number	Product Description	Case Qty	Pallet Qty	Distribution Center
Value+ Exit Signs						
VEGW	782343263020	912400348806	Universal Mount, Green Letters, White Thermoplastic Housing, AC Only	12	144	CA
VEGWEM	782343263044	912400348808	Universal Mount, Green Letters, White Thermoplastic Housing, Nicad battery	12	288	CA, TN, PA
VERW	782343263006	912400348805	Universal Mount, Red Letters, White Thermoplastic Housing, AC Only	12	384	CA, TN
VERWEM	782343263037	912400348807	Universal Mount, Red Letters, White Thermoplastic Housing, Nicad battery	12	288	CA, TN, PA, IL, GA*



Value+ LED Emergency Units

General purpose emergency product that features a low profile design giving it a stylish appeal suitable for any general purpose application.



Why choose Value+ Family?

- Wall, ceiling and surface mounting provisions
- Long life LED lamps
- 3.6V maintenance free nickel cadmium battery
- UL damp location listed



Value+ LED Emergency Units

Cat. No.	UPC Code	Model Number	Product Description	Case Qty	Pallet Qty	Dist. Center
Value+ Emergency Unit						
VLLU	784197038342	912401289498	Value + Economy Grade 3.6V LED Emergency white and (2) 1 watt LED lamps	12	96	CA, TN, PA, IL, GA*
VLLU2	784197043858	912401289502	Value + Economy Grade 3.6V LED Emergency white and (2) 2 watt LED lamps	12	96	CA, TN, PA





All sizes arrive fully assembled and ready to install

Slim Flood LED dual select

Fade-resistant, textured bronze finish with tempered glass lens that is heat and impact resistant

Why choose Slim Flood dual select?

- Complete family of LED floodlights ideal for illuminating signs, building facades or other dark areas
- Can be mounted on the ground, wall, or pole mounted
- Field selectable CCT of 3000–5000K
- Field selectable wattages 10–300W with 7 housing sizes & 4 mountings
- Photo Cell included 35–150W, Photo Cell option 205 & 300W
- IP65 rated, 5-year limited warranty¹



Slim Flood LED dual select

Catalog Number	UPC Code	Model No.	Product Description	Compliance	Case/Pallet Qty	Distribution Center
Slim Flood dual select						
SF15-SCT-K-G2-10-BZ	190096196005	911401874384	Slim Flood Dual Select 15W Max, 3CCT, UNV, Knuckle, Bronze	DLC Premium	1/180	TN, CA, PA
SF15-SCT-Y-G2-10-BZ	190096196012	911401874484	Slim Flood Dual Select 15W Max, 3CCT, UNV, Yoke, Bronze	DLC Premium	1/300	TN, CA, PA
SF35-SCT-K-G2-10-PCB-BZ	190096196029	911401874584	Slim Flood Dual Select 35W Max, 3CCT, UNV, Knuckle, Bronze	DLC Premium	1/180	TN, CA, PA
SF35-SCT-Y-G2-10-PCB-BZ	190096196036	911401874684	Slim Flood Dual Select 35W Max, 3CCT, UNV, Yoke, Bronze	DLC Premium	1/240	TN, CA, PA
SF60-SCT-K-G2-10-PCB-BZ	190096196043	911401874784	Slim Flood Dual Select 60W Max, 3CCT, UNV, Knuckle, Bronze	DLC Premium	1/120	TN, CA, PA
SF60-SCT-Y-G2-10-PCB-BZ	190096196050	911401874884	Slim Flood Dual Select 60W Max, 3CCT, UNV, Yoke, Bronze	DLC Premium	1/120	TN, CA, PA
SF100-SCT-S-G2-10-PCB-BZ	190096196067	911401874984	Slim Flood Dual Select 100W Max, 3CCT, UNV, Slip Fitter, PCB, Bronze	DLC Premium	1/60	TN, CA, PA
SF100-SCT-T-G2-10-PCB-BZ	190096196074	911401875084	Slim Flood Dual Select 100W Max, 3CCT, UNV, Trunion, PCB, Bronze	DLC Premium	1/90	TN, CA, PA
SF150-SCT-S-G2-10-PCB-BZ	190096196081	911401875184	Slim Flood Dual Select 150W Max, 3CCT, UNV, Slip Fitter, PCB, Bronze	DLC Premium	1/40	TN, CA, PA
SF150-SCT-T-G2-10-PCB-BZ	190096196098	911401875284	Slim Flood Dual Select 150W Max, 3CCT, UNV, Trunion, PCB, Bronze	DLC Premium	1/40	TN, CA, PA
SF205-SCT-S-G2-10-BZ	190096196104	911401875384	Slim Flood Dual Select 205W Max, 3CCT, UNV, Slip Fitter, PCB, Bronze	DLC Premium	1/24	TN, CA, PA
SF205-SCT-T-G2-10-BZ	190096196111	911401875484	Slim Flood Dual Select 205W Max, 3CCT, UNV, Trunion, PCB, Bronze	DLC Premium	1/24	TN, CA, PA
SF300-SCT-S-G2-10-BZ	190096196128	911401875584	Slim Flood Dual Select 300W Max, 3CCT, UNV, Slip Fitter, PCB, Bronze	DLC Premium	1/20	TN, CA, PA
SF300-SCT-T-G2-10-BZ	190096196135	911401875684	Slim Flood Dual Select 300W Max, 3CCT, UNV, Trunion, PCB, Bronze	DLC Premium	1/20	TN, CA, PA
SF205-300-PCB	190096196142	911401875784	Slim Flood, 120-150-205W PCB Accessory	DLC Premium	—	TN, CA, PA

1. See www.signify.com/warranties for details.

Wall Pack LED dual select

Classic design meets LED technology

The new Wall Pack dual select helps you upgrade from costly HID fixtures with confidence.



Why choose Wall Pack?

- An easy switch from costly HID fixture
- Field selectable wattage and color temperature
- Flexible options, built-in photocell, and field enable or disable
- Glass refractor lens design cuts down on glare



Wall Pack LED dual select

Catalog Number	UPC Code	Model Number	Product Description	Compliance	Case/Pallet Qty	Distribution Center
Wall Pack dual select						
WP100-SCT-G2-10-BZ	190096131341	911401872481	Selectable Wattage and CCT 80-100W / 30K-40K-50K, Bronze Finish	DLC Premium	2/24	CA, TN, PA, IL, GA*
WP60-SCT-G2-10-BZ	190096131334	911401872381	Selectable Wattage and CCT 28-40-60W / 30K-40K-50K, Bronze Finish	DLC Premium	2/24	CA, TN, PA, IL, GA*





Adj. Slim Wall Pack LED dual select

Slim, low profile LED design

Features a discreet design that will complement any building exterior. Two sizes are available, with three wattage and three CCT selectable options each.



Why choose Adjustable Slim Wall Pack?

- Wall, surface, low level mounting
- Die-cast aluminum, hinged
- Simplified solution – dual select
- 2 housing sizes (25W & 75W)
 - 25W (15/20/25W & 1800/2400/3000 lms)
 - 75W (45/60/75W & 5400/7200/9000 lms)
- CCT Selectable (3K/4K/5K) & 120-277V
- IP65 / IK07 Rated / DLC 5.1
- Button Photocontrol w/0-90° tilt option

Adjustable Slim Wall Pack LED dual select

Catalog Number	UPC Code	Model Number	Product Description	Compliance	Case/Pallet Qty	Distribution Center
Adjustable Slim Wall Pack						
ASW25-SCT-G1-8-PCB-BW	190096182039	912401591885	Adj Slim WP DS 15-25W/30-40-50K/UNV/PCB	DLC Premium	4/144	TN,CA,PA
ASW75-SCT-G1-8-PCB-BW	190096182046	912401591886	Adj Slim WP DS 45-75W/30-40-50K/UNV/PCB	DLC Premium	4/120	TN,CA,PA





© 2023 Signify Holding. All rights reserved. The information provided herein is subject to change, without notice. Signify does not give any representation or warranty as to the accuracy or completeness of the information included herein and shall not be liable for any action in reliance thereon. The information presented in this document is not intended as any commercial offer and does not form part of any quotation or contract, unless otherwise agreed by Signify.

Signify North America Corporation
400 Crossing Blvd, Suite 600
Bridgewater, NJ 08807
Telephone: 855-486-2216

Signify Canada Ltd.
281 Hillmount Road,
Markham, ON, Canada L6C 2S3
Telephone: 800-668-9008

All trademarks are owned by Signify Holding or their respective owners.